









C 60 SERİ PROFİL LİSTESİ

C 60 SERIES PROFILES INDEX

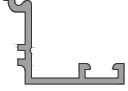

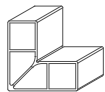
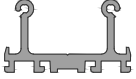

PROFİL NUM. PROFILE NO.	TANIM DESCRIPTION	ÇİZİM DRAWING	SAYFA PAGE
4197	KASA VE ORTA KAYIT PROFİLİ FRAME AND TRANSOM PROFILE		9
19128	KASA VE ORTA KAYIT PROFİLİ FRAME AND TRANSOM PROFILE		9
4184	KASA VE ORTA KAYIT PROFİLİ FRAME AND TRANSOM PROFILE		9
4182	KASA VE ORTA KAYIT PROFİLİ FRAME AND TRANSOM PROFILE		9
4149	TAKVİYELİ KASA VE ORTA KAYIT PROFİLİ REINFORCED FRAME AND TRANSOM PROFILE		10
19129	KANAT PROFİLİ SASH PROFILE		10
4185	KANAT PROFİLİ SASH PROFILE		10
4178	KANAT PROFİLİ SASH PROFILE		11
4189	ETEK PROFİLİ PLINTH PROFILE		11
4150	135° DÖNÜŞ PROFİLİ CORNER PROFILE		12
4186	90° DÖNÜŞ PROFİLİ CORNER PROFILE		12
4183	KASA ADAPTÖRÜ ADAPTOR PROFILE FOR FRAME		12
4148	KASA ADAPTÖRÜ ADAPTOR PROFILE FOR FRAME		12
4148-D	KASA ADAPTÖRÜ ADAPTOR PROFILE FOR FRAME		12
4187	KASA ADAPTÖRÜ ADAPTOR PROFILE FOR FRAME		12

PROFİL NUM. PROFILE NO.	TANIM DESCRIPTION	ÇİZİM DRAWING	SAYFA PAGE
1639	TİJ PROFİLİ PUSHING ROD PROFILE		13
1439	PENCERE ADAPTÖR PROFİLİ ADAPTOR PROFILE FOR SASH		13
4188	CAM ÇITASI GLASS BEAD		13
4181	CAM ÇITASI GLASS BEAD		13
4179	CAM ÇITASI GLASS BEAD		13
3272	KÖŞE TAKOZU CORNER CLEAT		14
4507	KÖŞE TAKOZU CORNER CLEAT		14
4500	ORTA KAYIT BAĞLANTI T CONNECTION		14
4180	DİKEY BAĞLANTI VERTICAL CONNECTION		14

SARAY®

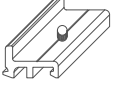
**C 60 SERİ CONTA VE
AKSESUARLAR**

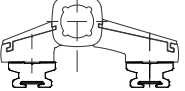
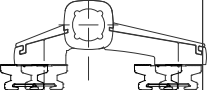
**C 60 SERIES GASKETS AND
ACCESSORIES**

AKSESUAR KODU ACCESSORY CODE	ÇİZİM DRAWING	MALZEME MATERIAL	MALZEME TANIMI DESCRIPTION	KOLİ / PAKET PACKAGE
SC-048		Alüminyum Aluminium	94 Seri İspanyolet Karşılığı Cremona Mechanism Striker	50 Ad/Koli 50 Pcs/Package
SC-261		Metal Metal	İspanyolet Pim Cremona Mechanism Pin	100 Ad/Koli 100 Pcs/Package
SDKM-45-075		Alüminyum Aluminium	Düz Kapazlama Menteşe Surface Mounting Hinge	10 Ad/Koli 10 Pcs/Package
SDKM-57-076		Alüminyum Aluminium	Düz Kapazlama Menteşe Surface Mounting Hinge	10 Ad/Koli 10 Pcs/Package
SC-881-D		Alüminyum Aluminium	Dilli Kilit Karşılığı (Beyaz Boyalı) Locking Device Striker (White Painted)	1 Ad/Koli 1 Pcs/Package
SC-882-D			Dilli Kilit Karşılığı (Özel Renkler) Locking Device Striker (Special Colors)	
SC-883-D			Dilli Kilit Karşılığı (Mat/Parlak Eloksallı) Locking Device Striker (Mate/Bright Anodising)	
SC-881-M			Makaralı Kilit Karşılığı (Beyaz Boyalı) Locking Device Striker (White Painted)	1 Ad/Koli 1 Pcs/Package
SC-882-M			Makaralı Kilit Karşılığı (Özel Renkler) Locking Device Striker (Special Colors)	
SC-883-M			Makaralı Kilit Karşılığı (Mat/Parlak Eloksallı) Locking Device Striker (Mate/Bright Anodising)	

AKSESUAR KODU ACCESSORY CODE	ÇİZİM DRAWING	MALZEME MATERIAL	MALZEME TANIMI DESCRIPTION	KOLİ / PAKET PACKAGE
SC-250		Alüminyum Aluminium	Gömme Sürgü / (Beyaz Boyalı) Embedded Bolt/ (White Painted)	5 Adet 5 Pieces
SC-251			Gömme Sürgü / (Eloksal) Embedded Bolt/ (Anodising)	
SC-252			Gömme Sürgü / (Özel Renkler) Embedded Bolt/ (Special Colors)	

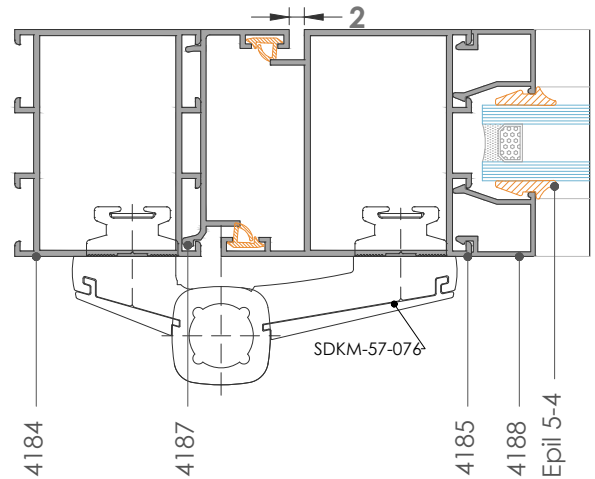
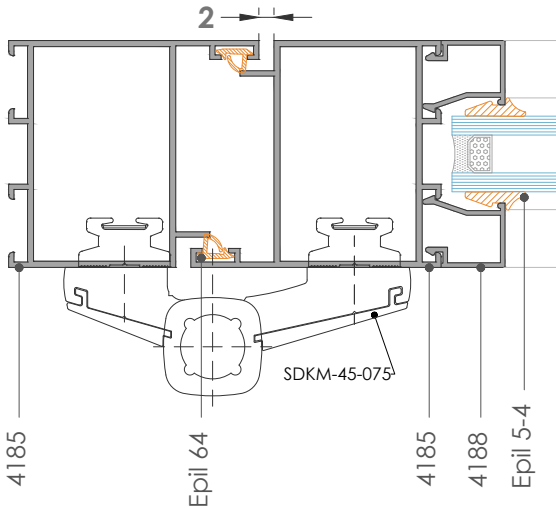
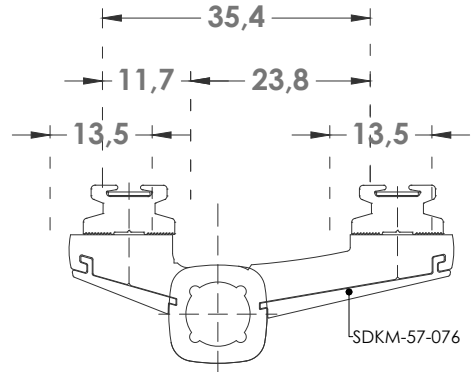
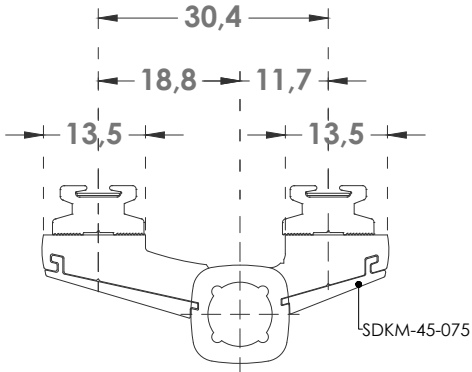
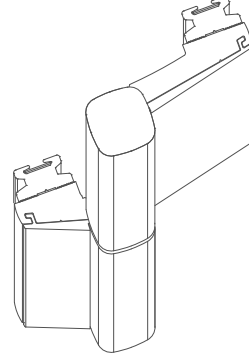
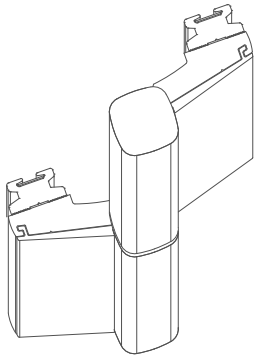

AKSESUAR KODU ACCESSORY CODE	MALZEME TANIMI DESCRIPTION	ÇİZİM DRAWING	MALZEME MATERIAL
EPİL 5-2	CAM FİTİLİ 2 mm / GLAZING GASKET 2 mm KOLİ MİKTARI / PACKAGE QUANTITY: 400 m / 17.6 kg		EPDM
EPİL 5-3	CAM FİTİLİ 3 mm / GLAZING GASKET 3 mm KOLİ MİKTARI / PACKAGE QUANTITY: 370 m / 17 kg		EPDM
EPİL 5-4	CAM FİTİLİ 4 mm / GLAZING GASKET 4 mm KOLİ MİKTARI / PACKAGE QUANTITY: 270 m / 17 kg		EPDM
EPİL 5-5	CAM FİTİLİ 5 mm / GLAZING GASKET 5 mm KOLİ MİKTARI / PACKAGE QUANTITY: 230 m / 17 kg		EPDM
EPİL 61	BİNİ FİTİLİ / OVERLAP GASKET KOLİ MİKTARI / PACKAGE QUANTITY: 380 m / 13.6 kg		EPDM

SARAY®

C 60 SERİ PROFİLLERİ
C 60 SERIES PROFILES

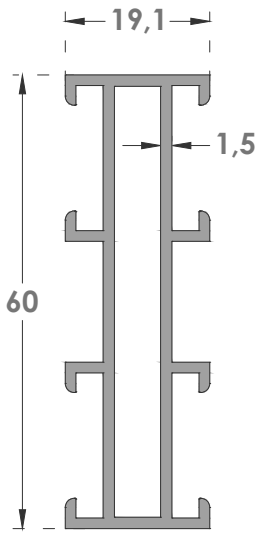

4197	
JX (cm ⁴) 10,58	JY (cm ⁴) 0,70
AĞIRLIK / WEIGHT (KG/M) 0,765	

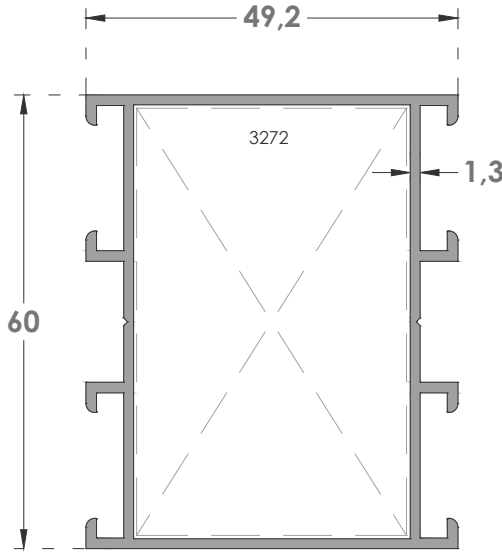

19128	
JX (cm ⁴) 16,64	JY (cm ⁴) 10,91

AĞIRLIK / WEIGHT
(KG/M)
0,905

KÖŞE TAKOZLARI
CORNER CLEATS

TAKOZ 3272

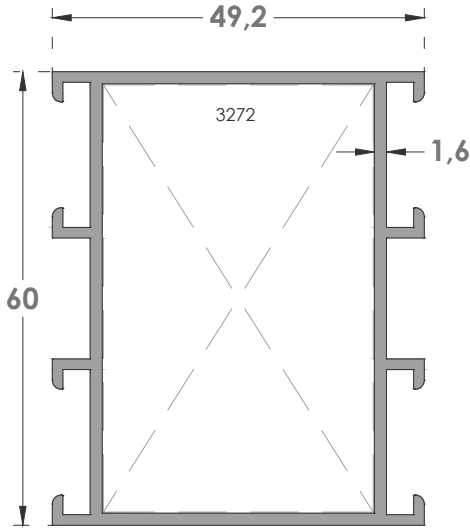

4184	
JX (cm ⁴) 19,27	JY (cm ⁴) 12,17
AĞIRLIK / WEIGHT (KG/M) 1,010	

KÖŞE TAKOZLARI
CORNER CLEATS

TAKOZ 3272

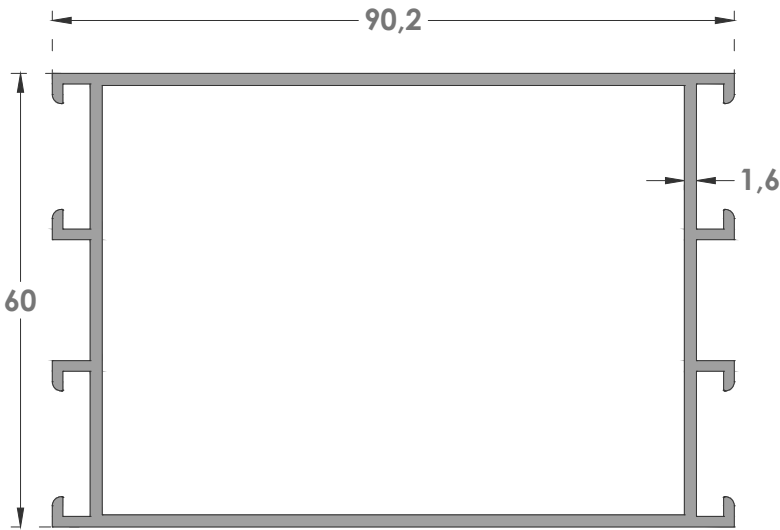

4182	
JX (cm ⁴) 30,47	JY (cm ⁴) 56,83

AĞIRLIK / WEIGHT
(KG/M)
1,345

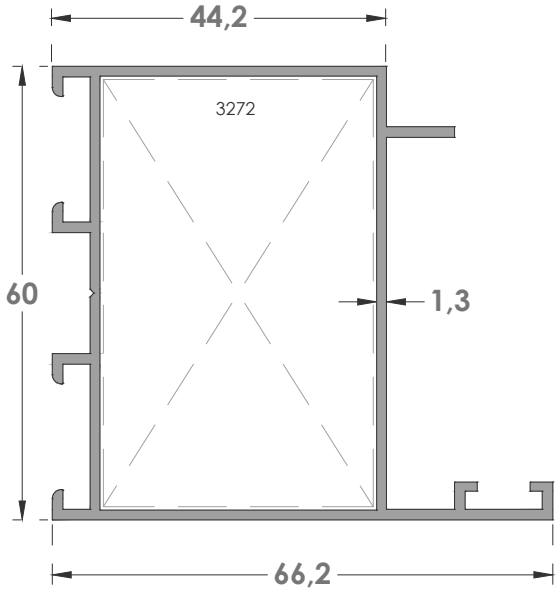
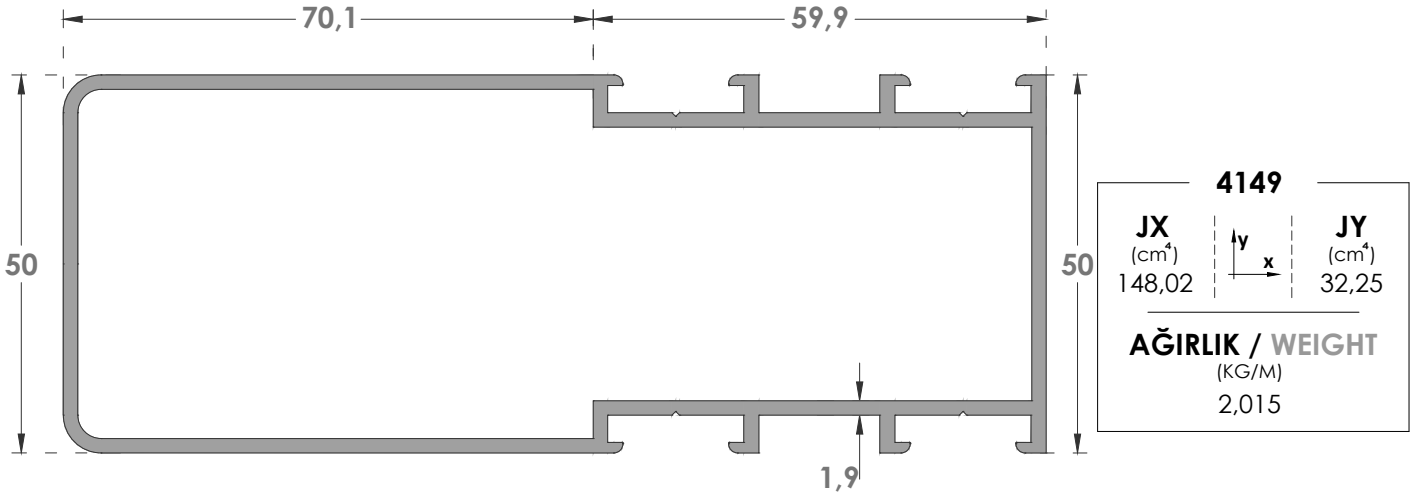

19129	
JX (cm ⁴) 18,82	JY (cm ⁴) 13,77
AĞIRLIK / WEIGHT (KG/M) 0,950	
KÖŞE TAKOZLARI CORNER CLEATS	
TAKOZ 3272	

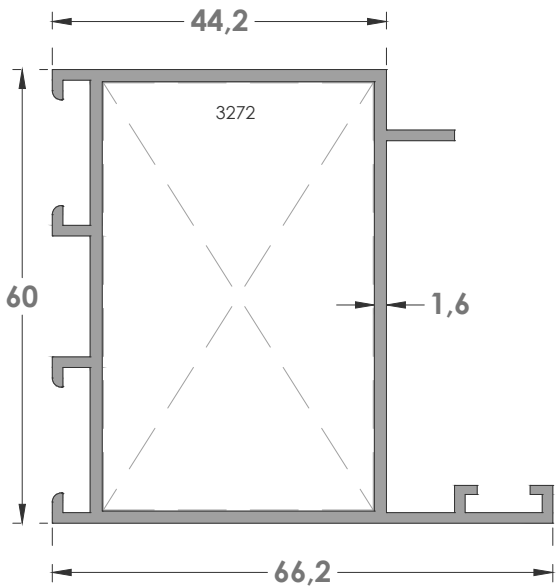

4185	
JX (cm ⁴) 21,34	JY (cm ⁴) 15,40
AĞIRLIK / WEIGHT (KG/M) 1,060	
KÖŞE TAKOZLARI CORNER CLEATS	
TAKOZ 3272	

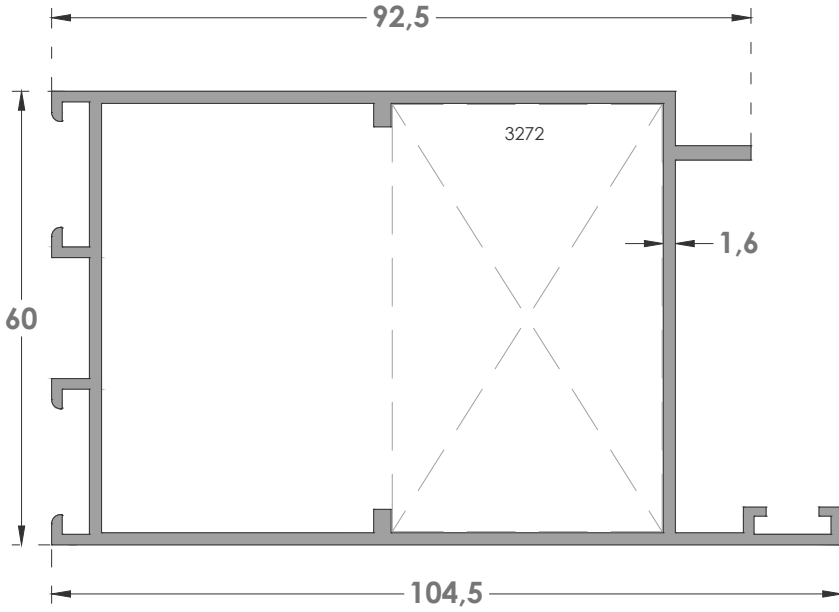

4178

JX
(cm⁴)
32,72

JY
(cm⁴)
62,06

AĞIRLIK / WEIGHT
(KG/M)
1,500

KÖŞE TAKOZLARI
CORNER CLEATS

TAKOZ 3272

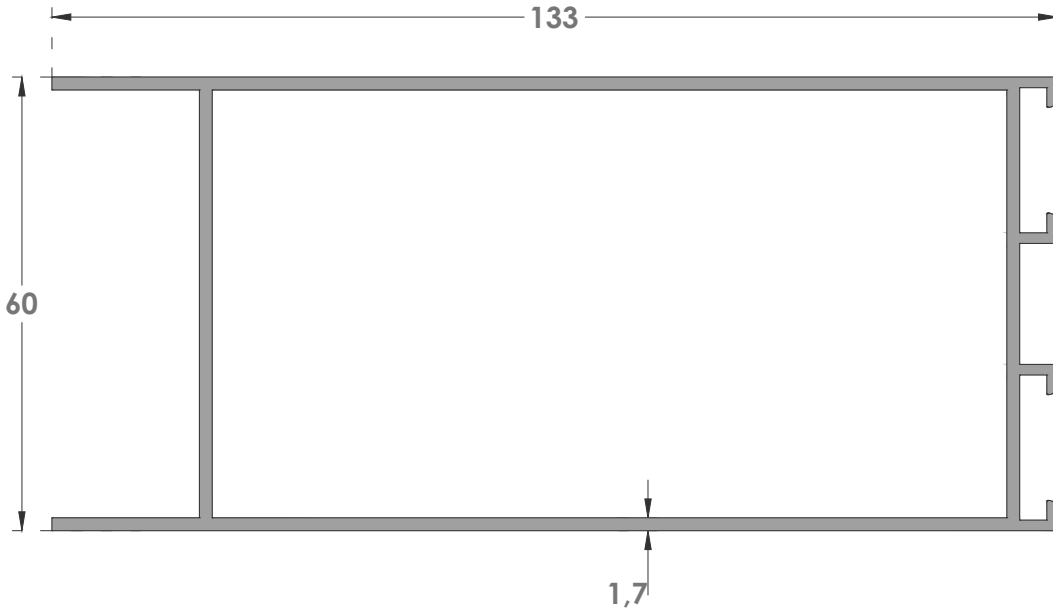

4189

JX
(cm⁴)
131,18

JY
(cm⁴)
43,98

AĞIRLIK / WEIGHT
(KG/M)
1,820

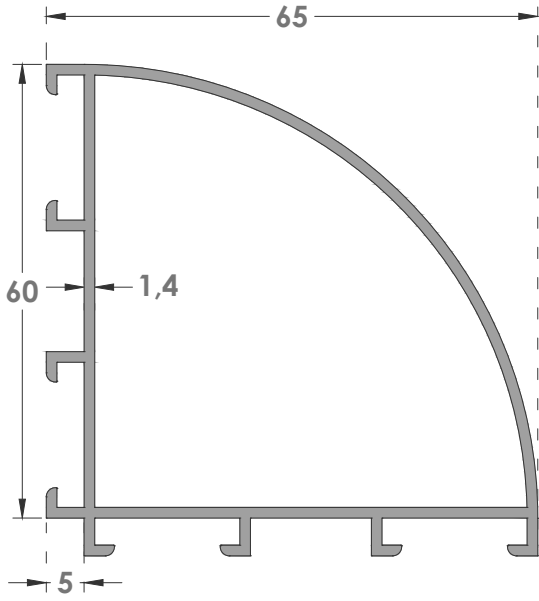

4186		
JX (cm ⁴) 18,65	$\begin{matrix} y \\ \\ x \end{matrix}$	JY (cm ⁴) 18,65
AĞIRLIK / WEIGHT (KG/M) 1,020		

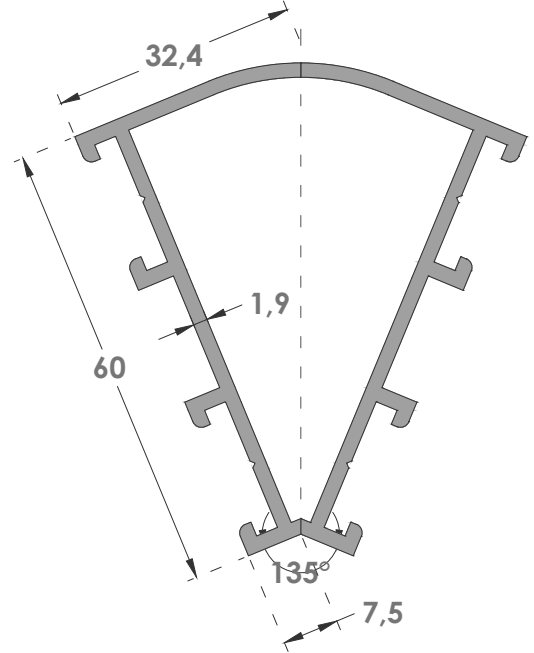

4150		
JX (cm ⁴) 17,92	$\begin{matrix} y \\ \\ x \end{matrix}$	JY (cm ⁴) 10,19
AĞIRLIK / WEIGHT (KG/M) 1,105		

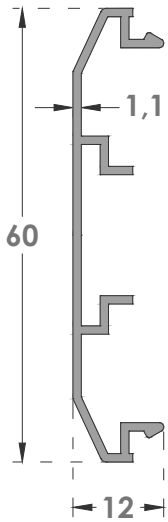

4183
AĞIRLIK / WEIGHT (KG/M.) 0,325

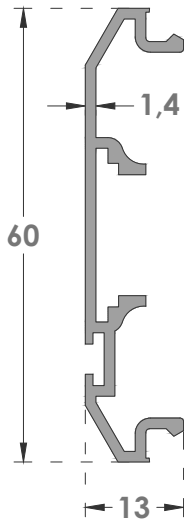

4148
AĞIRLIK / WEIGHT (KG/M.) 0,430

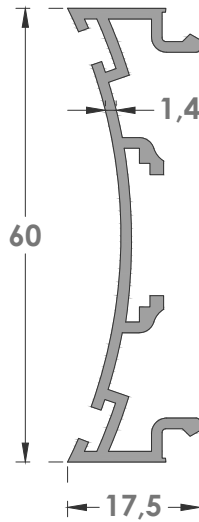

4148-D
AĞIRLIK / WEIGHT (KG/M.) 0,505

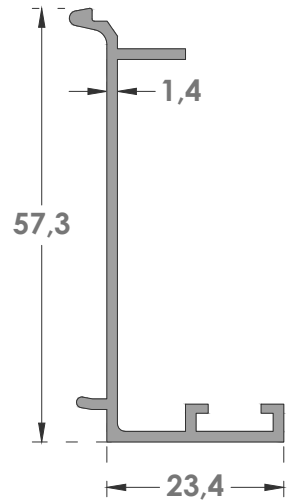

4187
AĞIRLIK / WEIGHT (KG/M.) 0,410

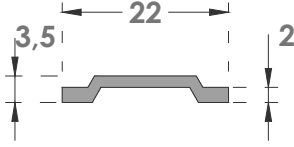

1639

AĞIRLIK / WEIGHT
(KG/M.)
0,115

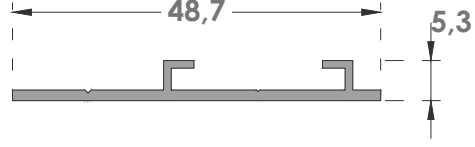

1439

AĞIRLIK / WEIGHT
(KG/M.)
0,225

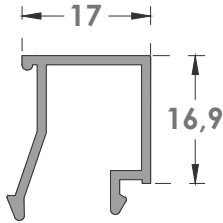

4188

AĞIRLIK / WEIGHT
(KG/M.)
0,215

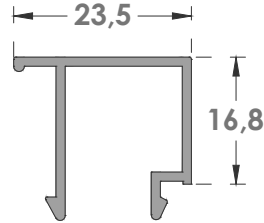

4181

AĞIRLIK / WEIGHT
(KG/M.)
0,240

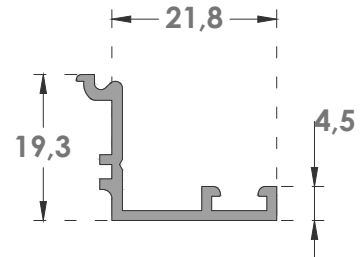

4179

AĞIRLIK / WEIGHT
(KG/M.)
0,210

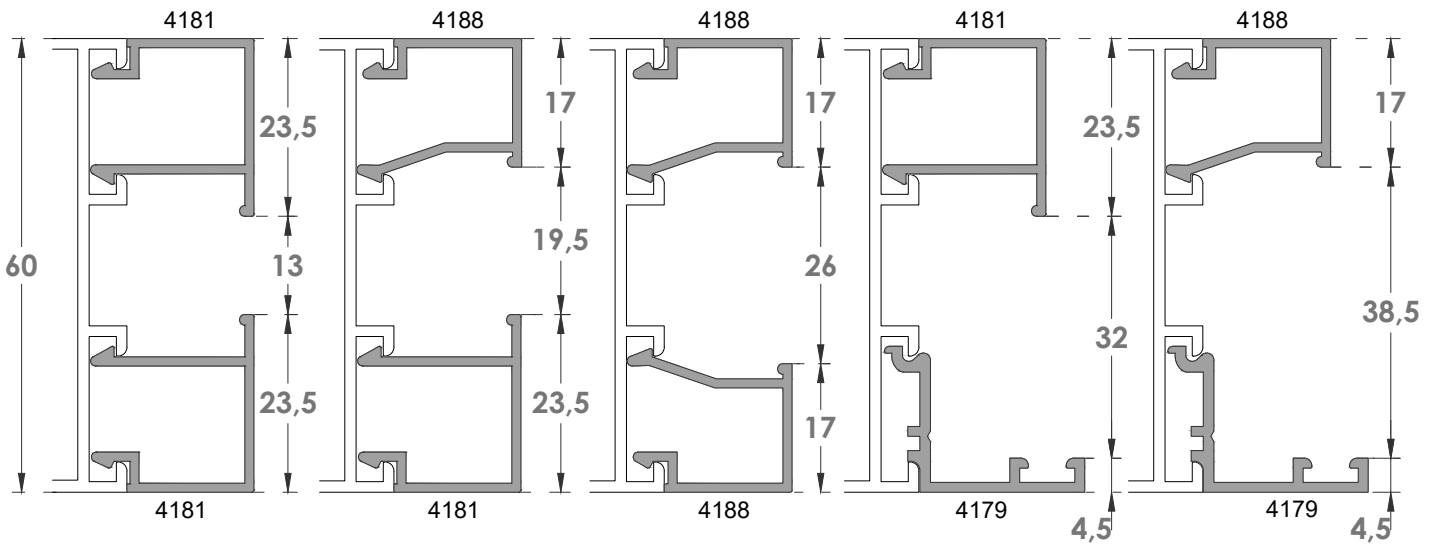

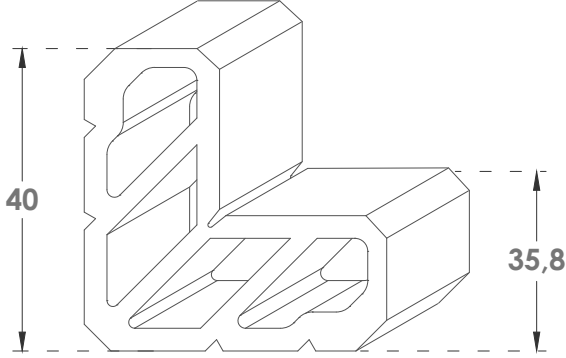

3272

AĞIRLIK / WEIGHT
(KG/M.)
6,230

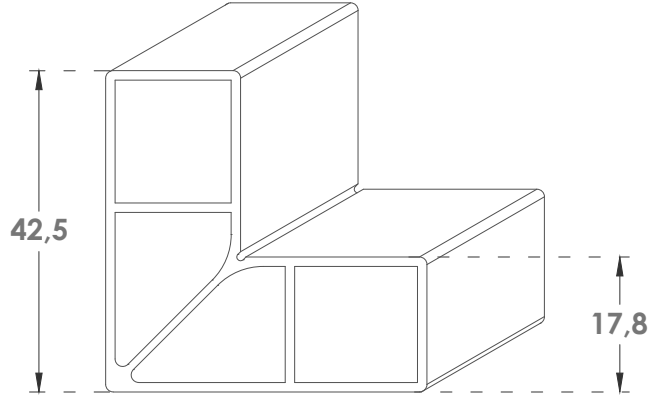

4507

AĞIRLIK / WEIGHT
(KG/M.)
2,930

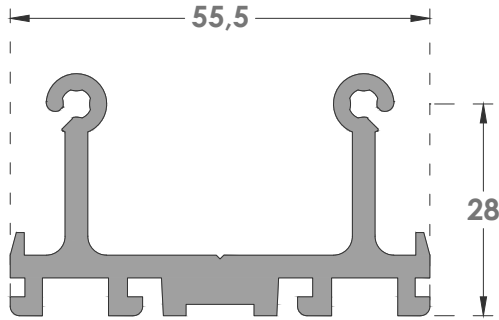

4500

AĞIRLIK / WEIGHT
(KG/M.)
1,285

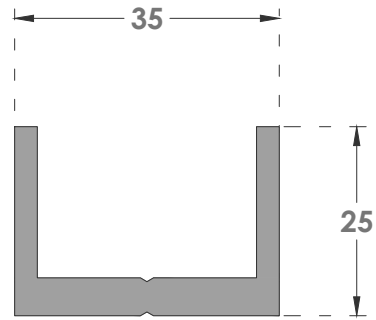

4180

AĞIRLIK / WEIGHT
(KG/M.)
0,800

C 60 SERİ DETAYLARI

C 60 SERIES DETAILS

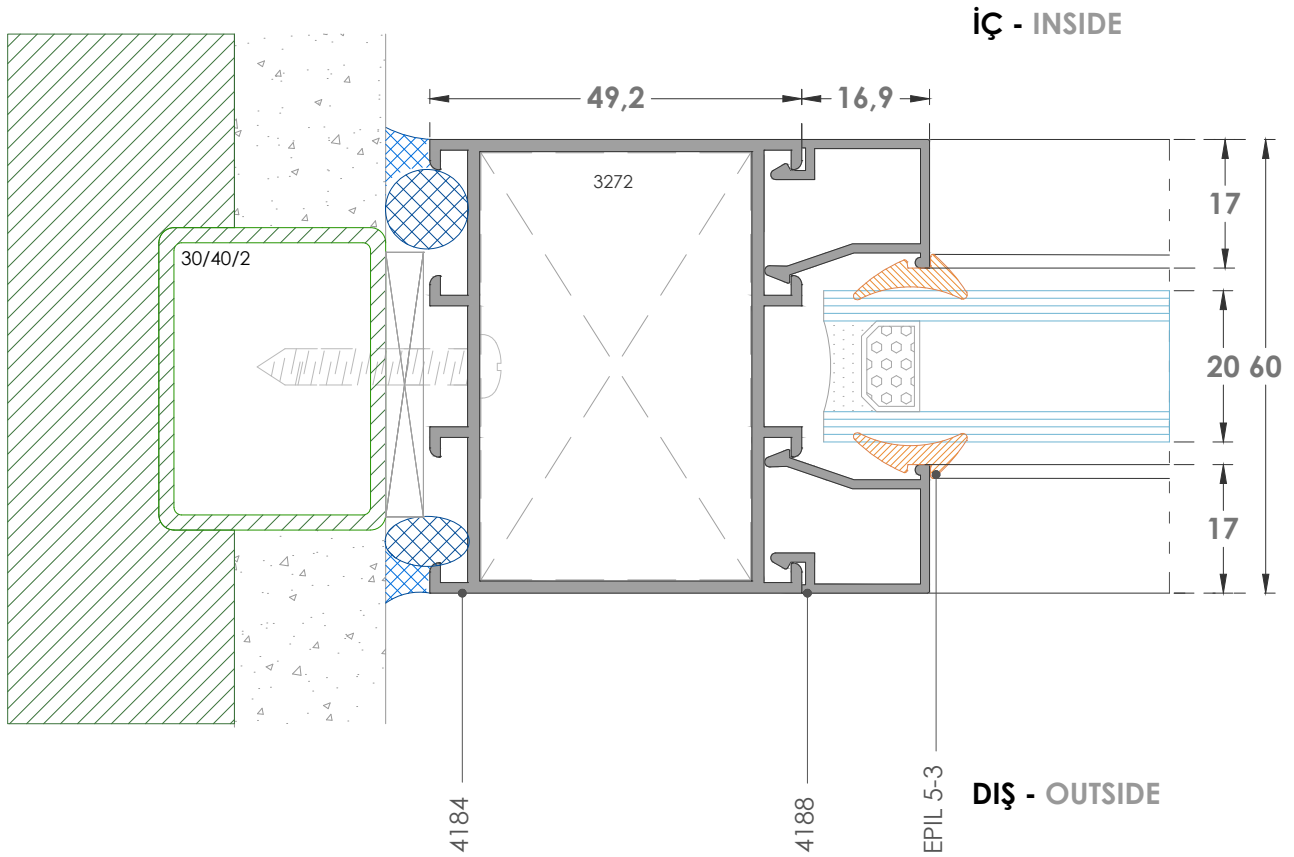
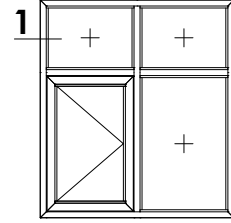

01

Detay-Detail

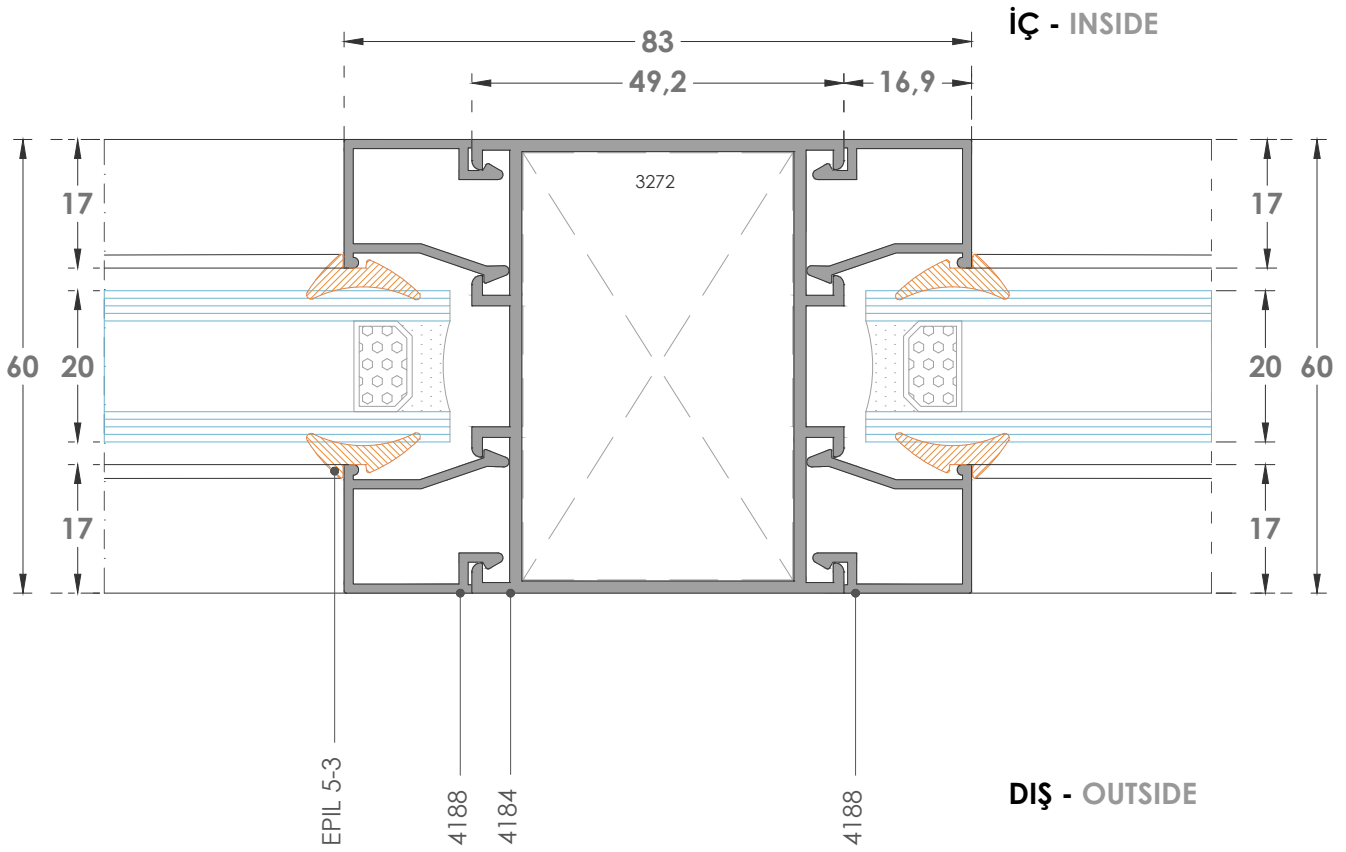
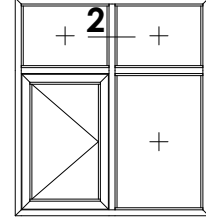

02
Detay-Detail

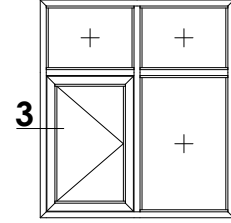

3

İÇ - INSIDE

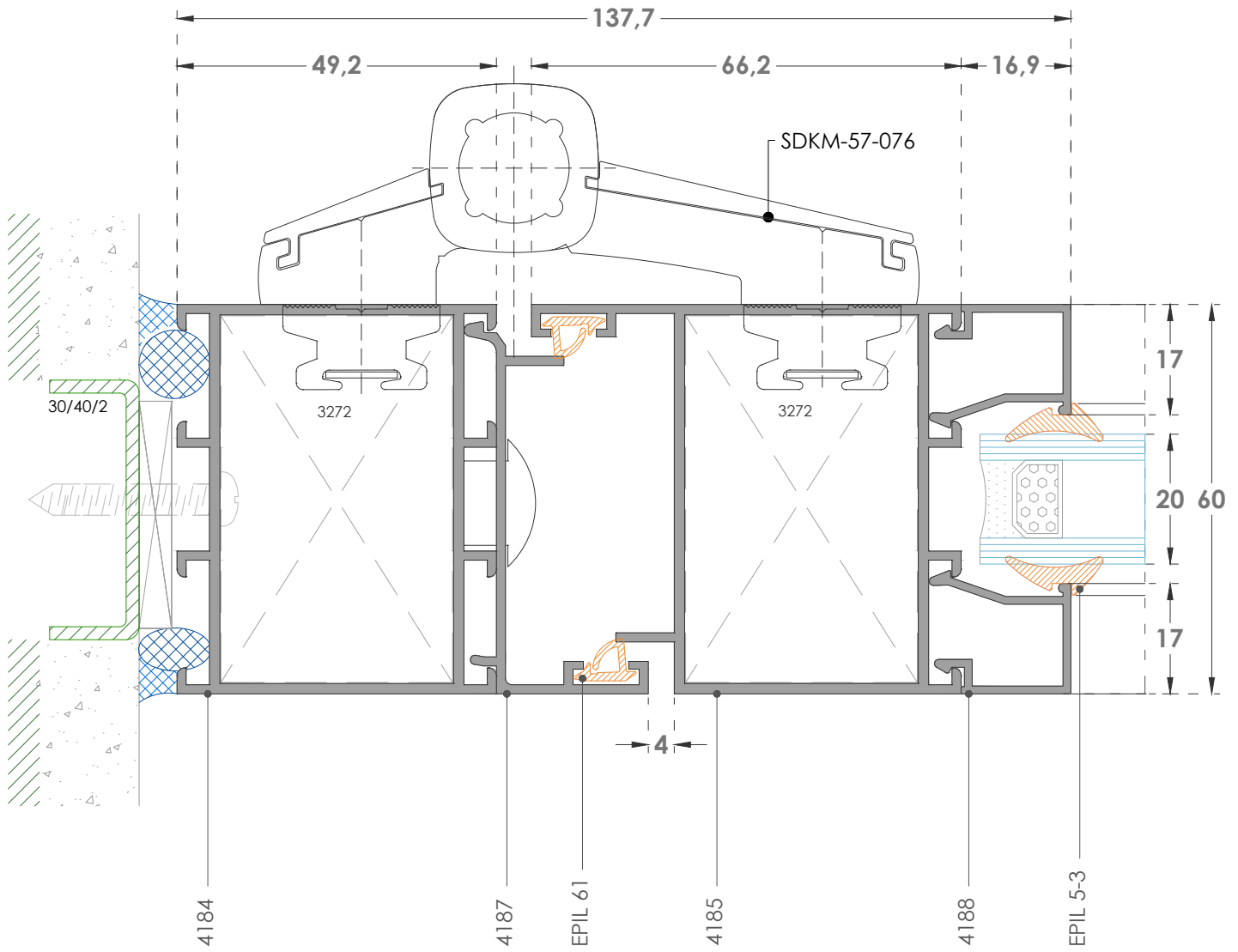

03

Detay-Detail

DIŞ - OUTSIDE

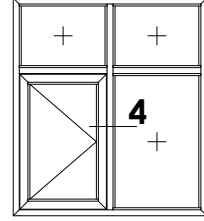

iÇ - INSIDE

4188

4184

4187

SC-048

EPIL 61

1639

1639

1439

4185

EPIL 5-3

DIŞ - OUTSIDE

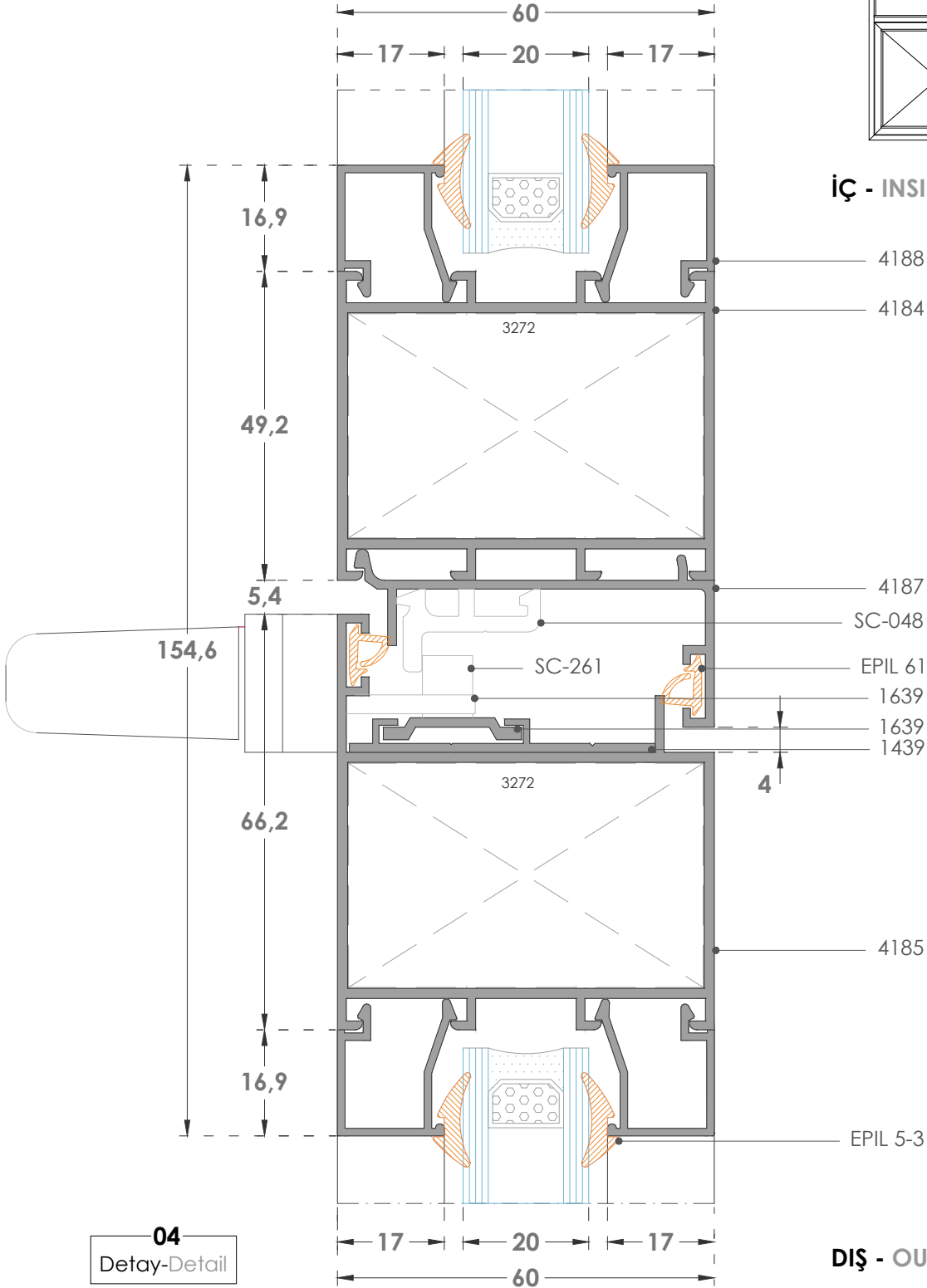

04
Detay-Detail

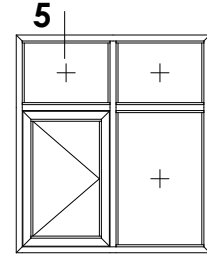

İÇ - INSIDE

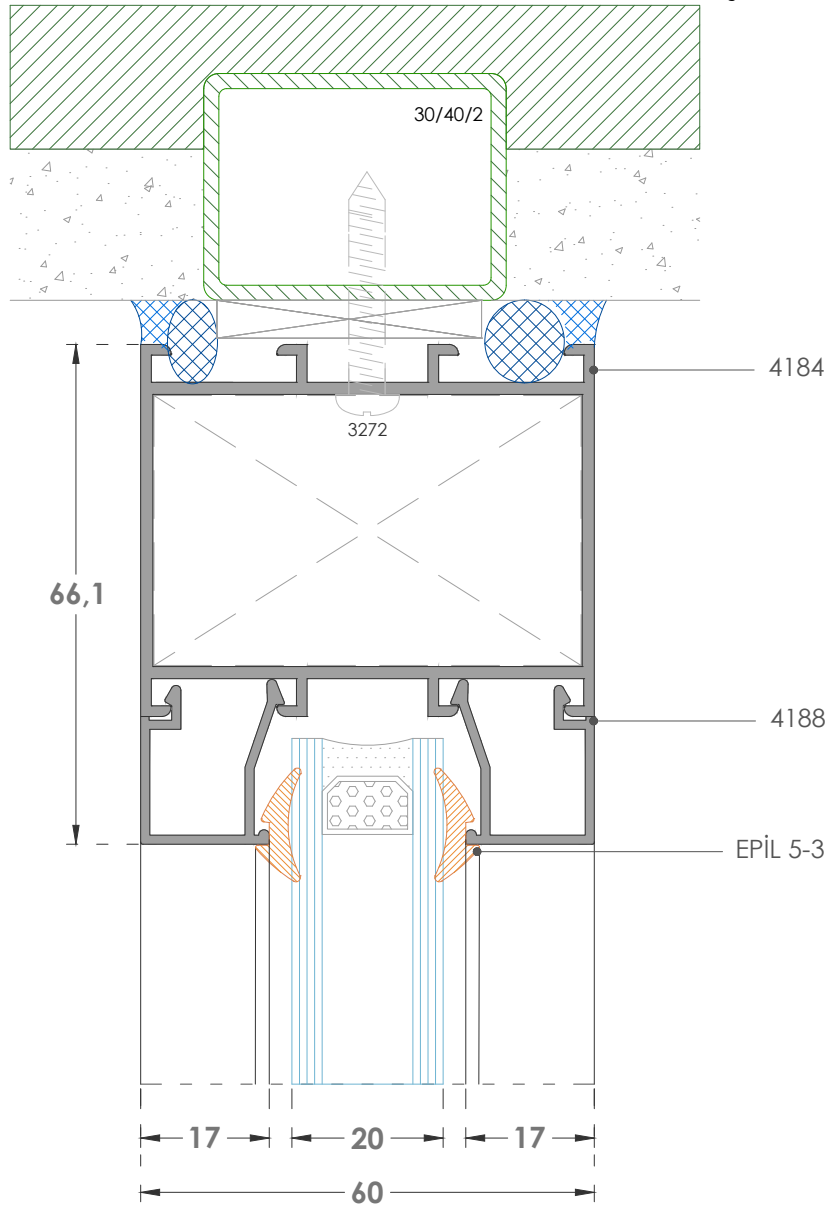

05

Detay-Detail

DİŞ - OUTSIDE

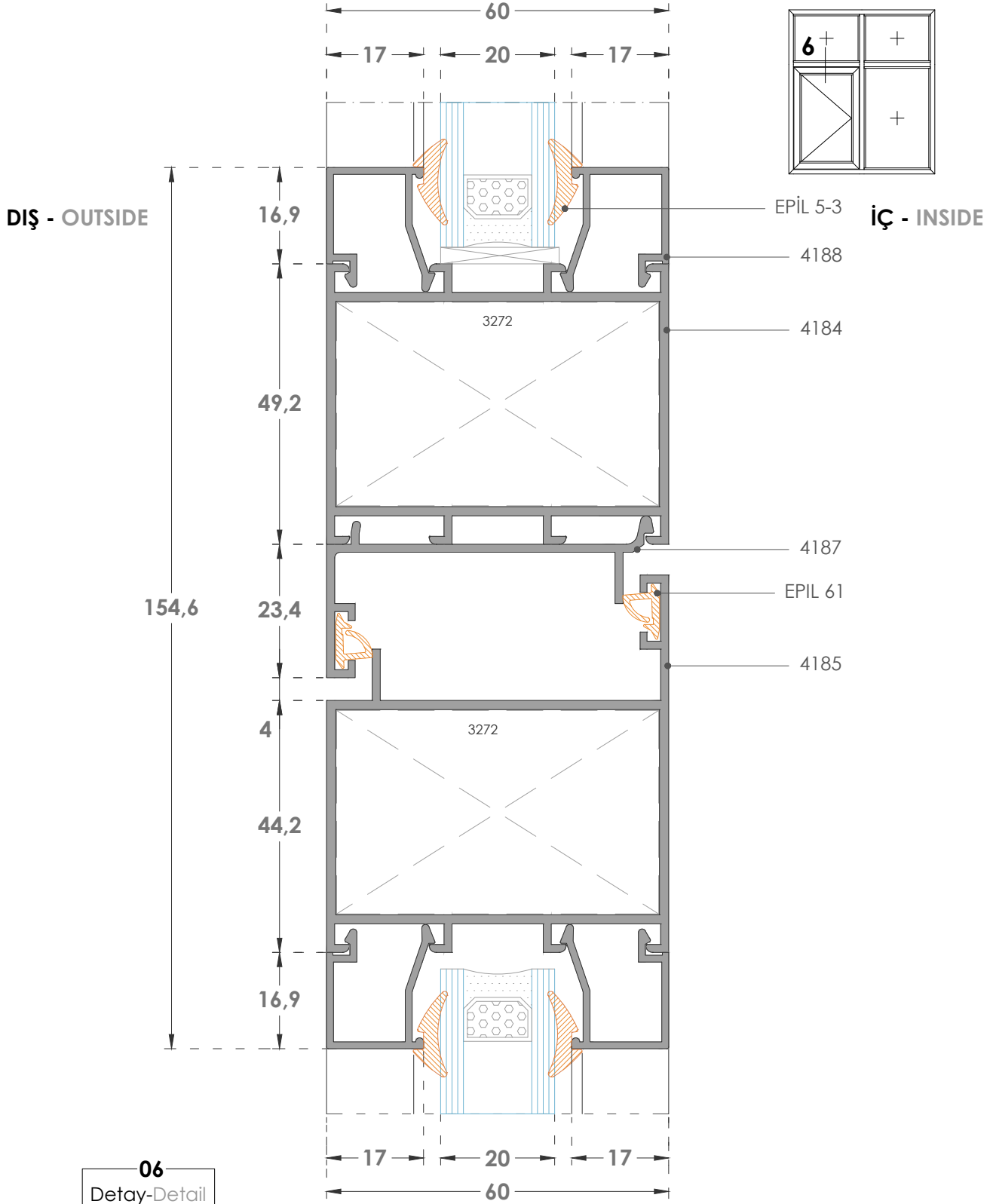

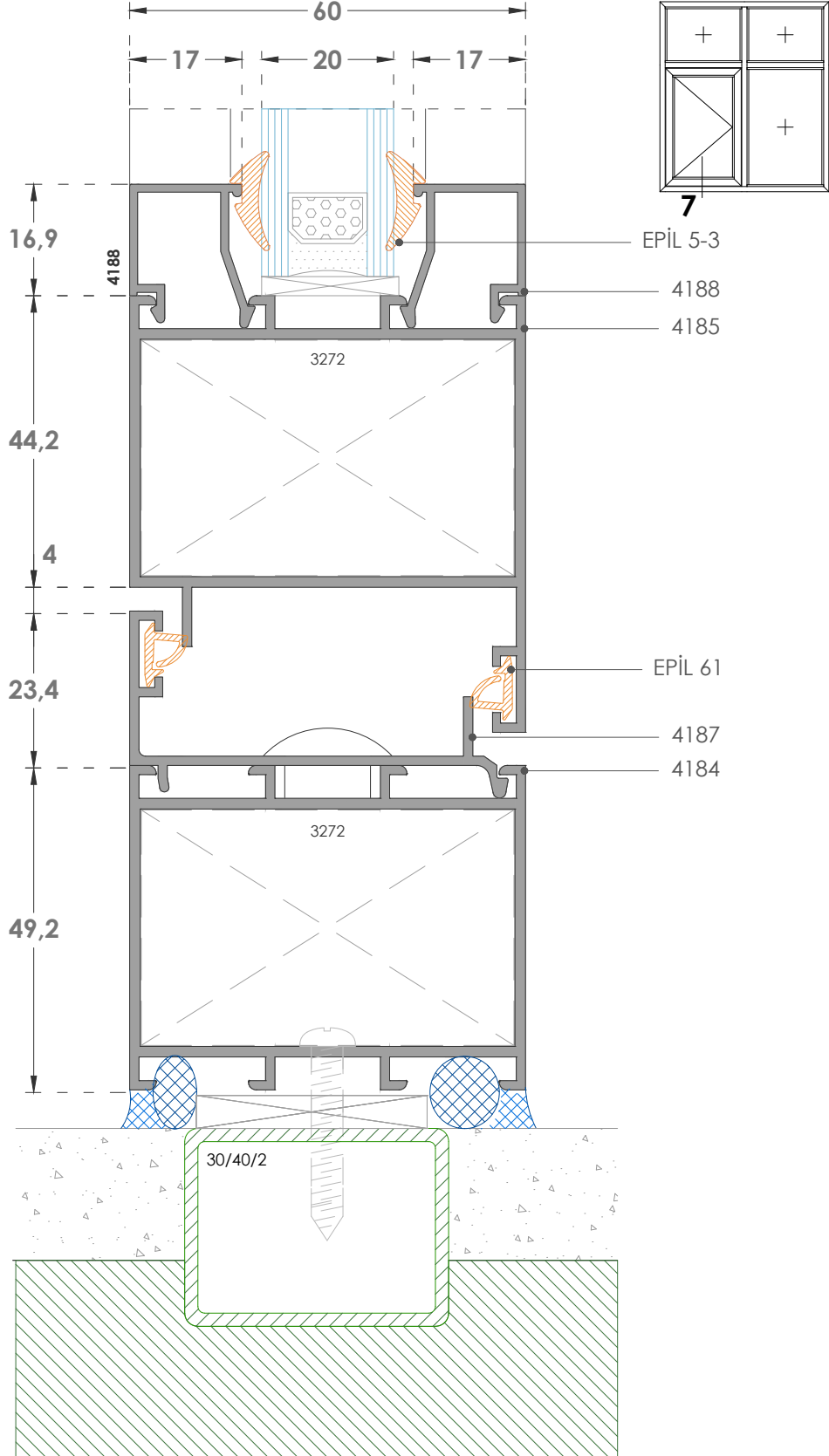

07
Detay-Detail

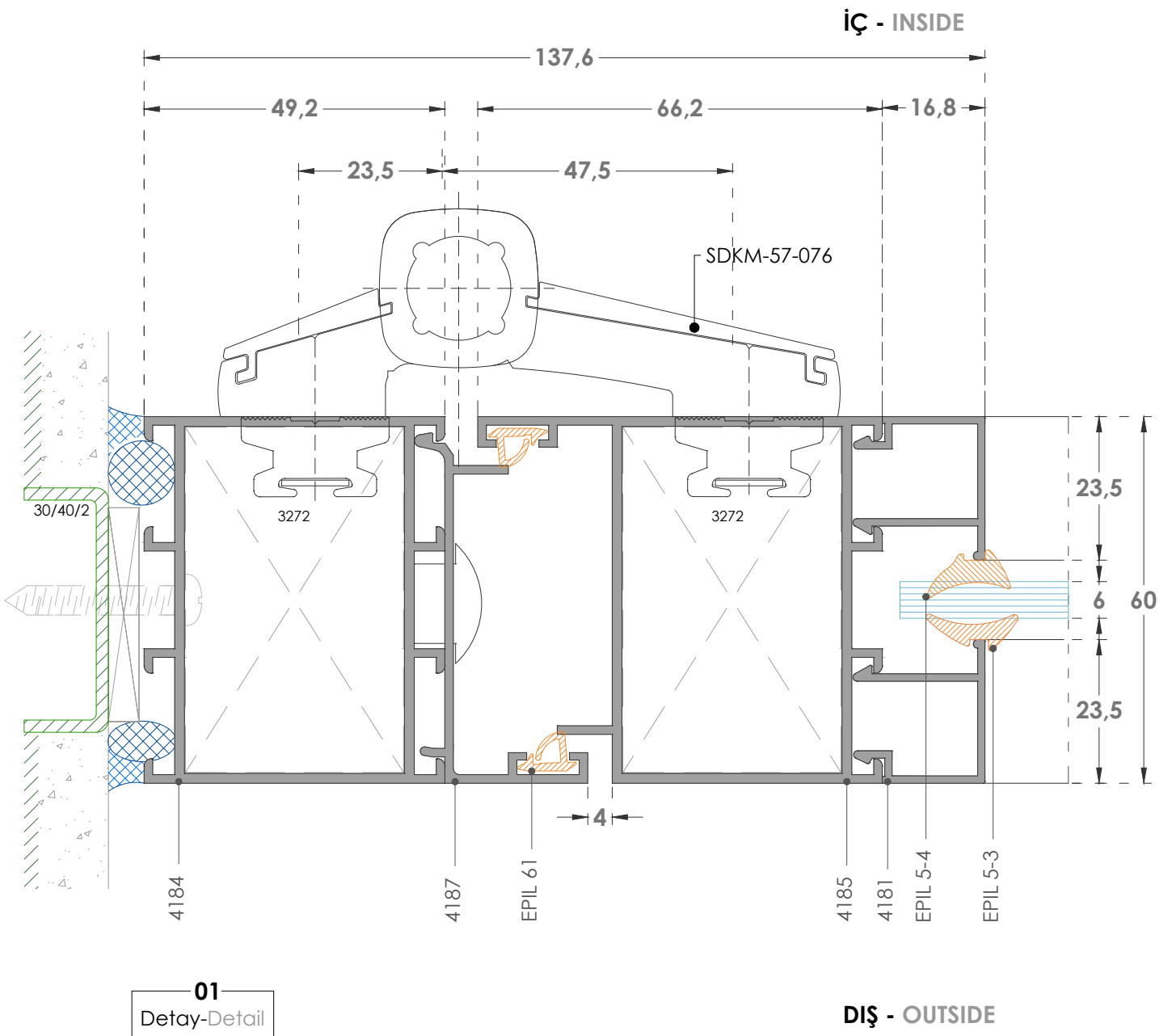
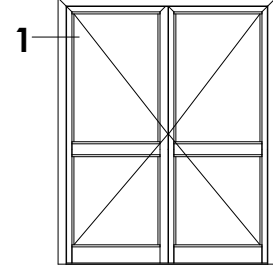

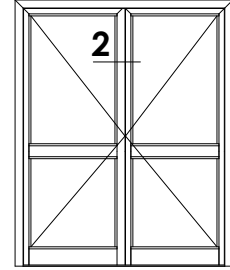
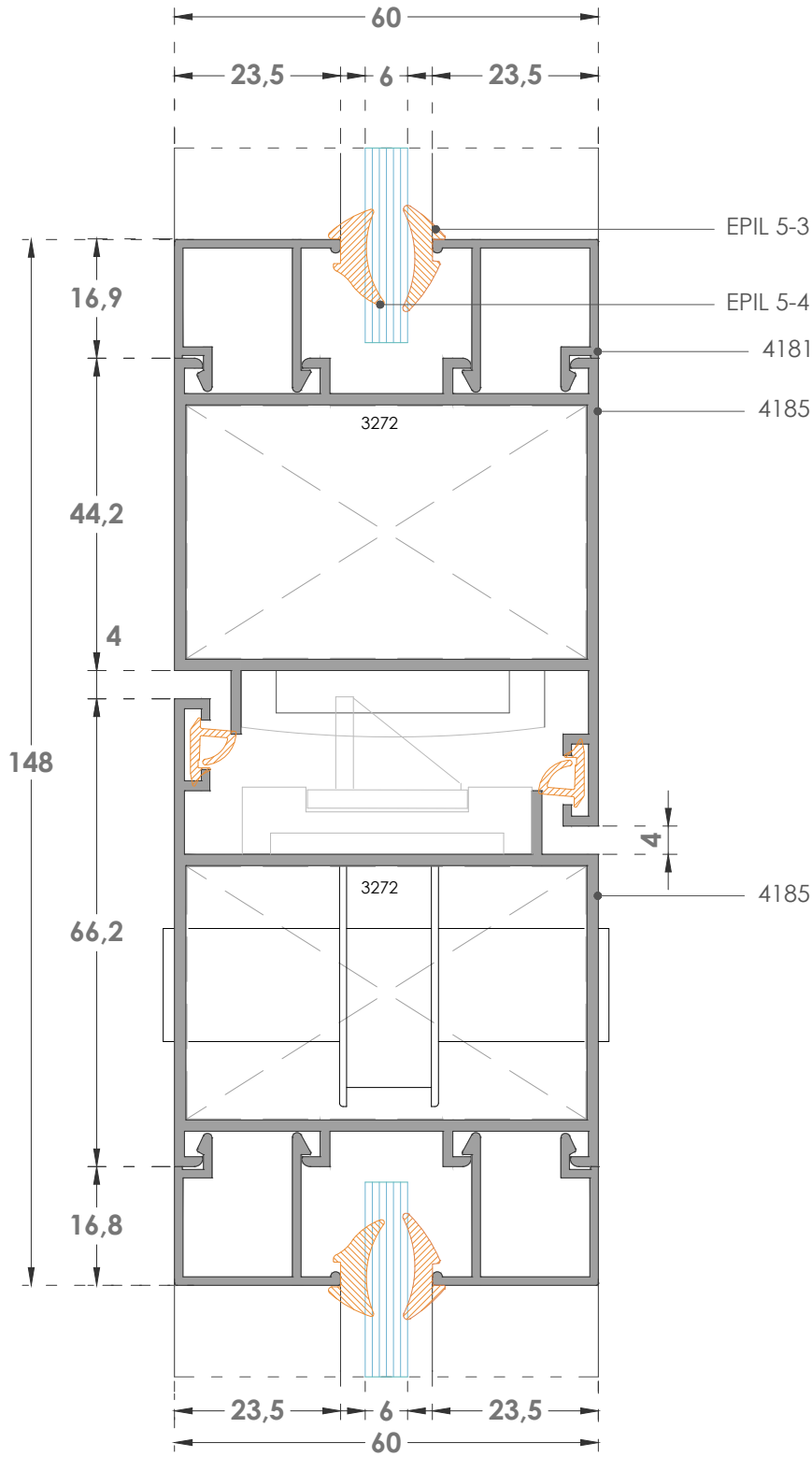

İÇ - INSIDE

DIŞ - OUTSIDE

02
Detay-Detail

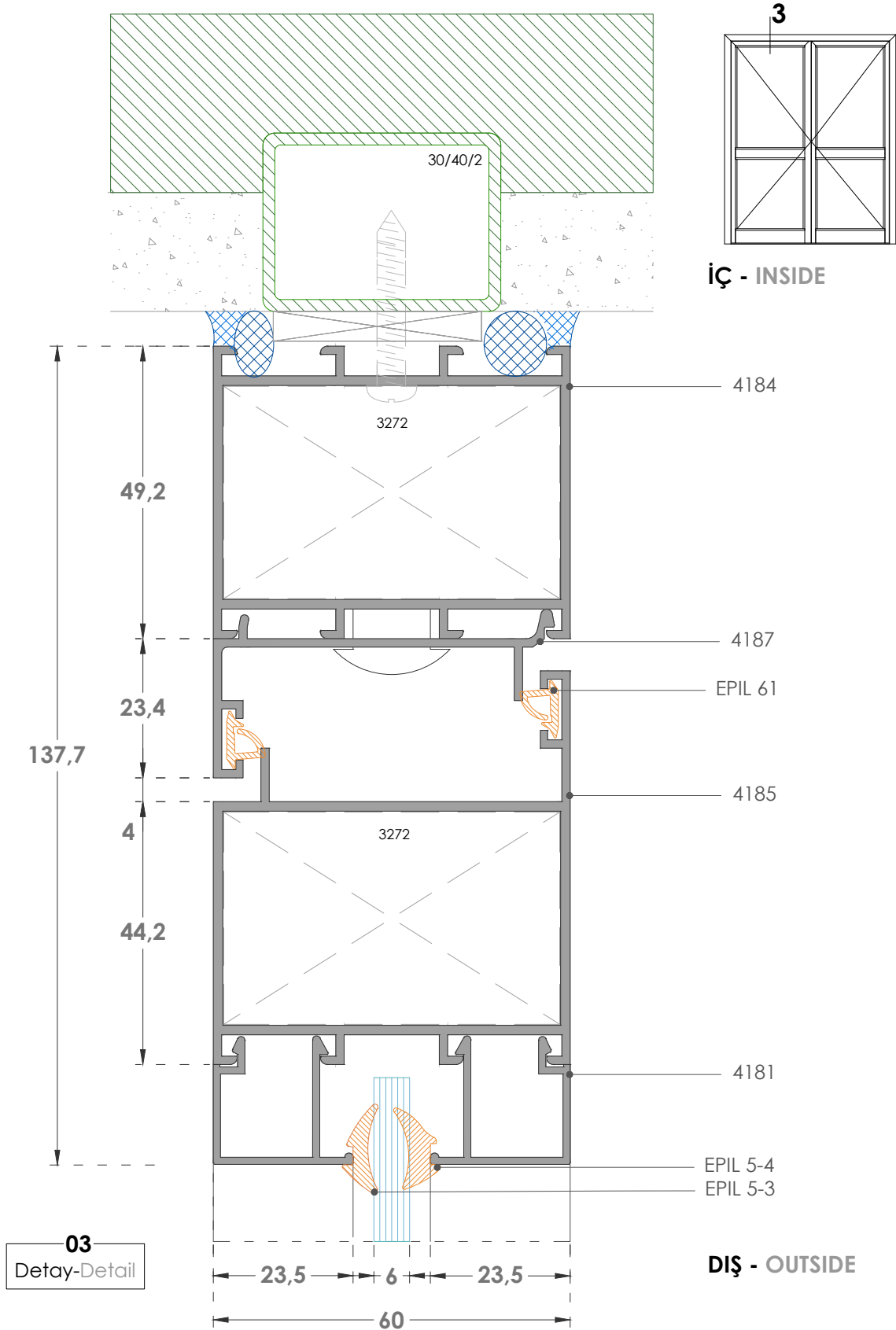

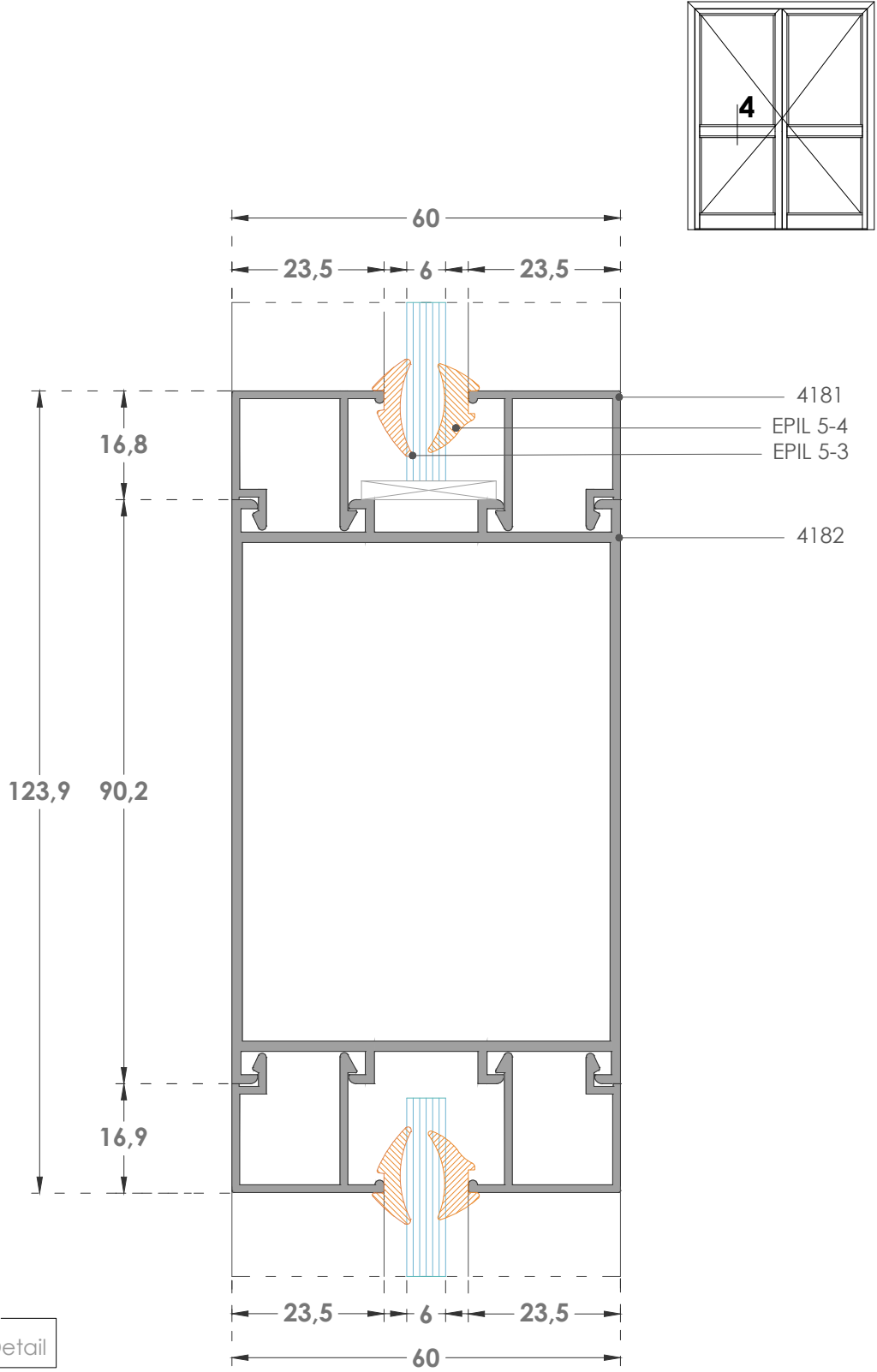

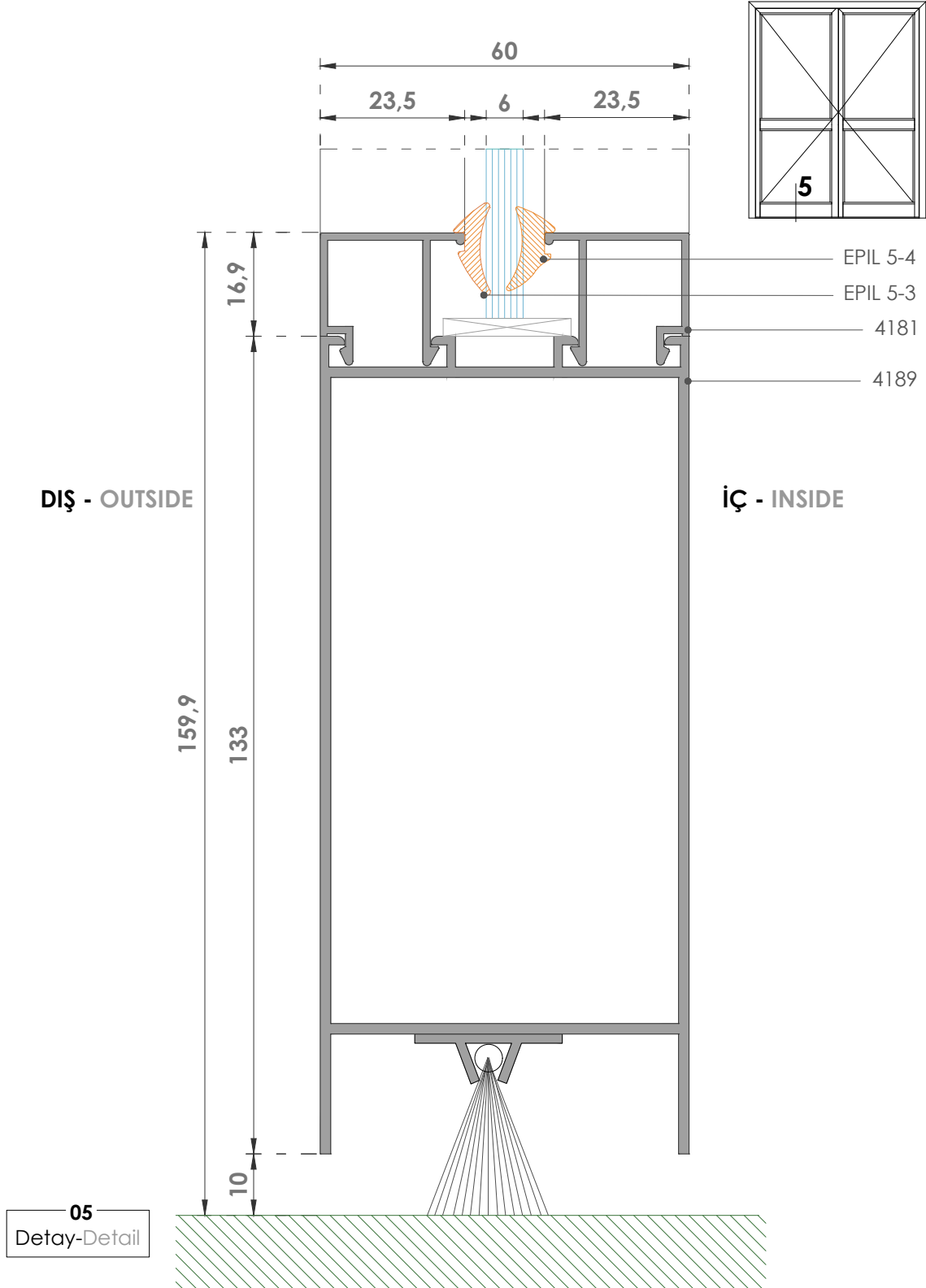

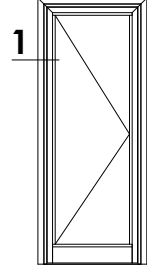

İÇ - INSIDE

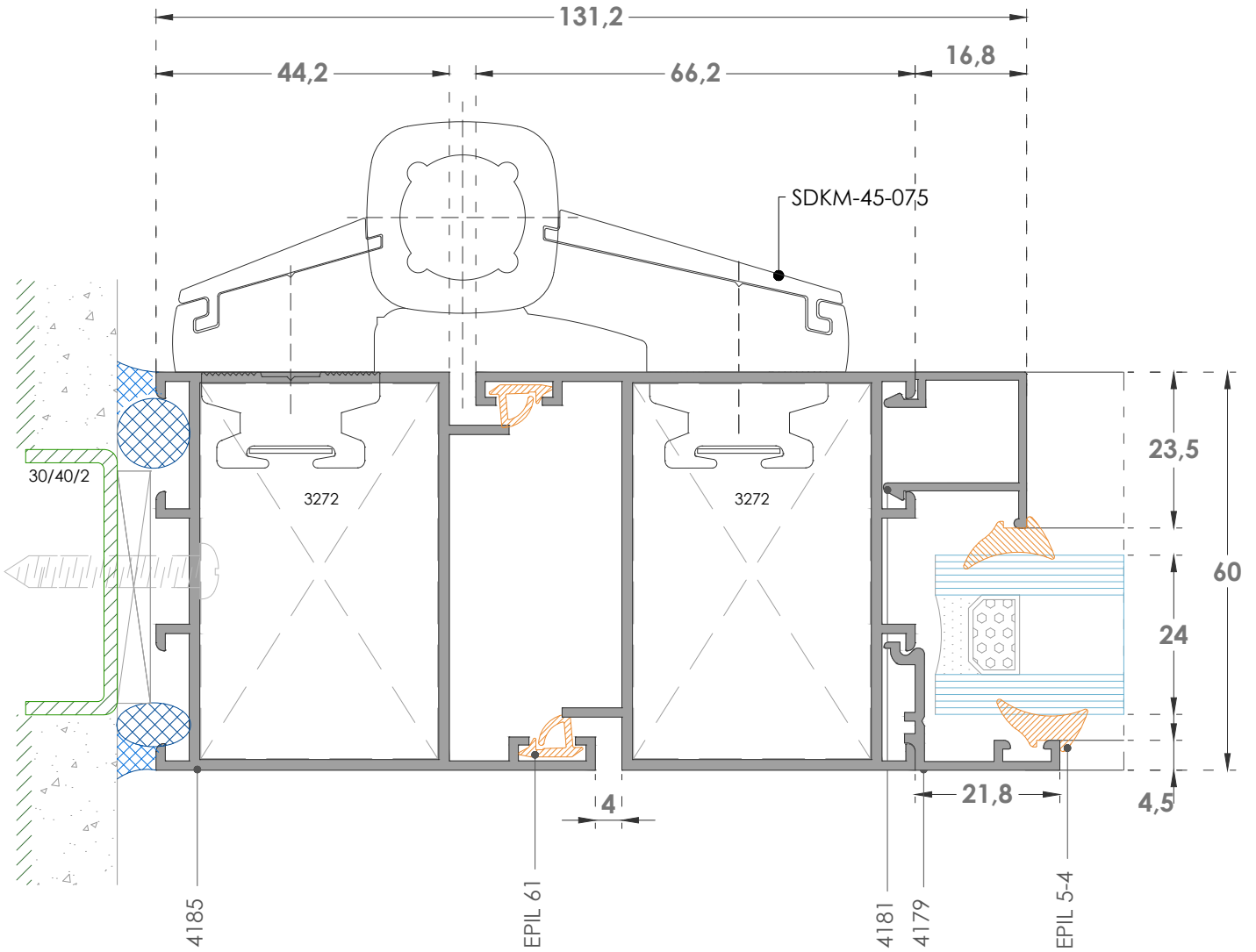

01

Detay-Detail

DIŞ - OUTSIDE

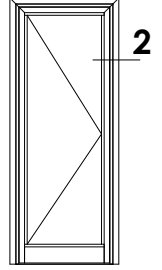

İÇ - INSIDE

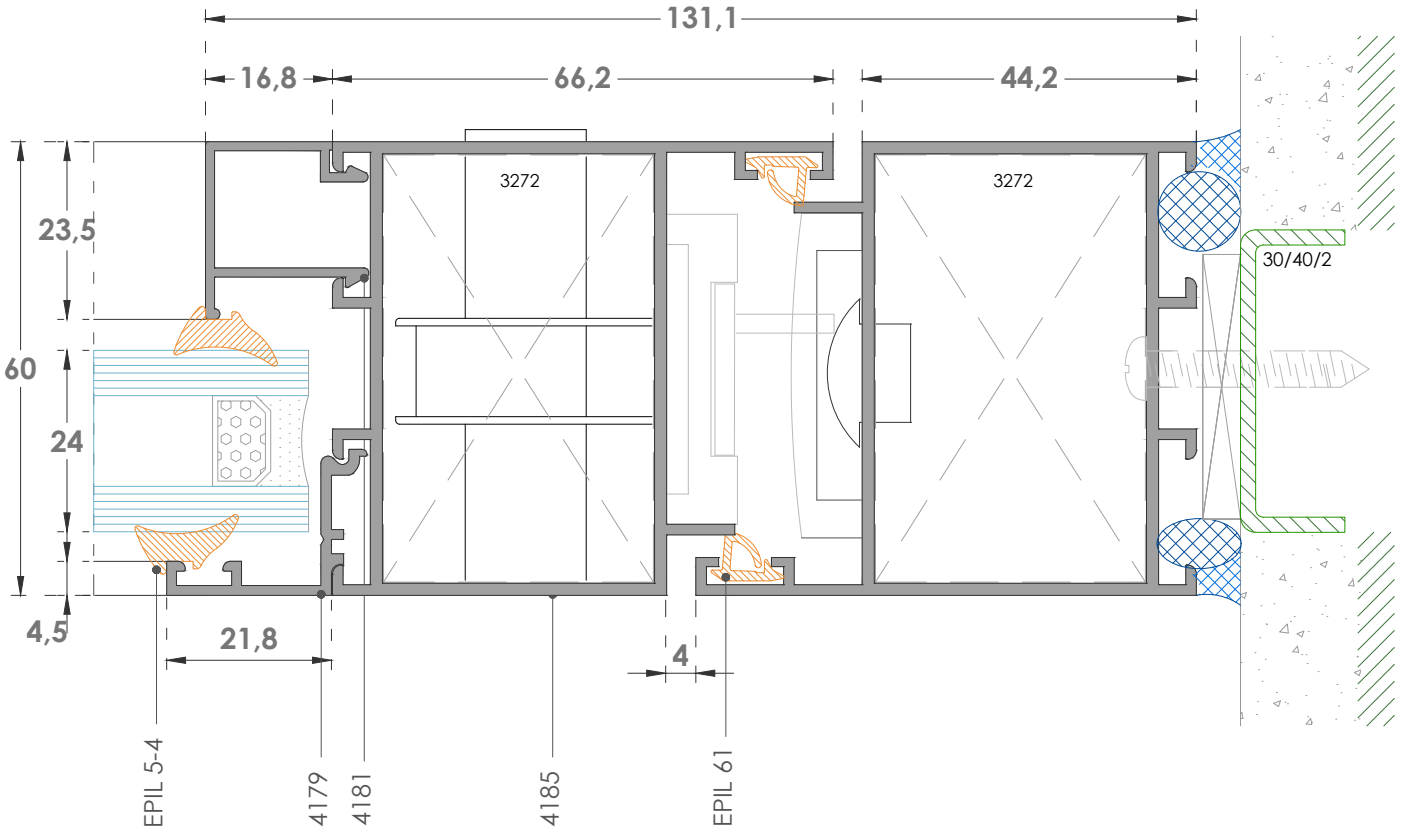

02

Detay-Detail

DIŞ - OUTSIDE

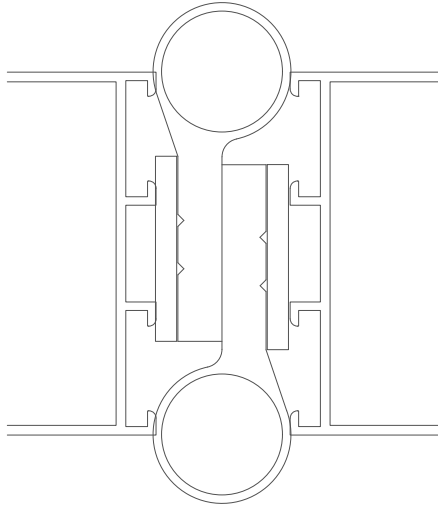

ÇARPMA KAPI / SWING DOOR

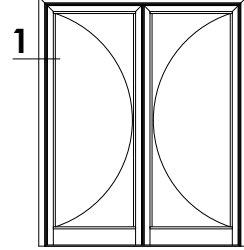

İÇ - INSIDE

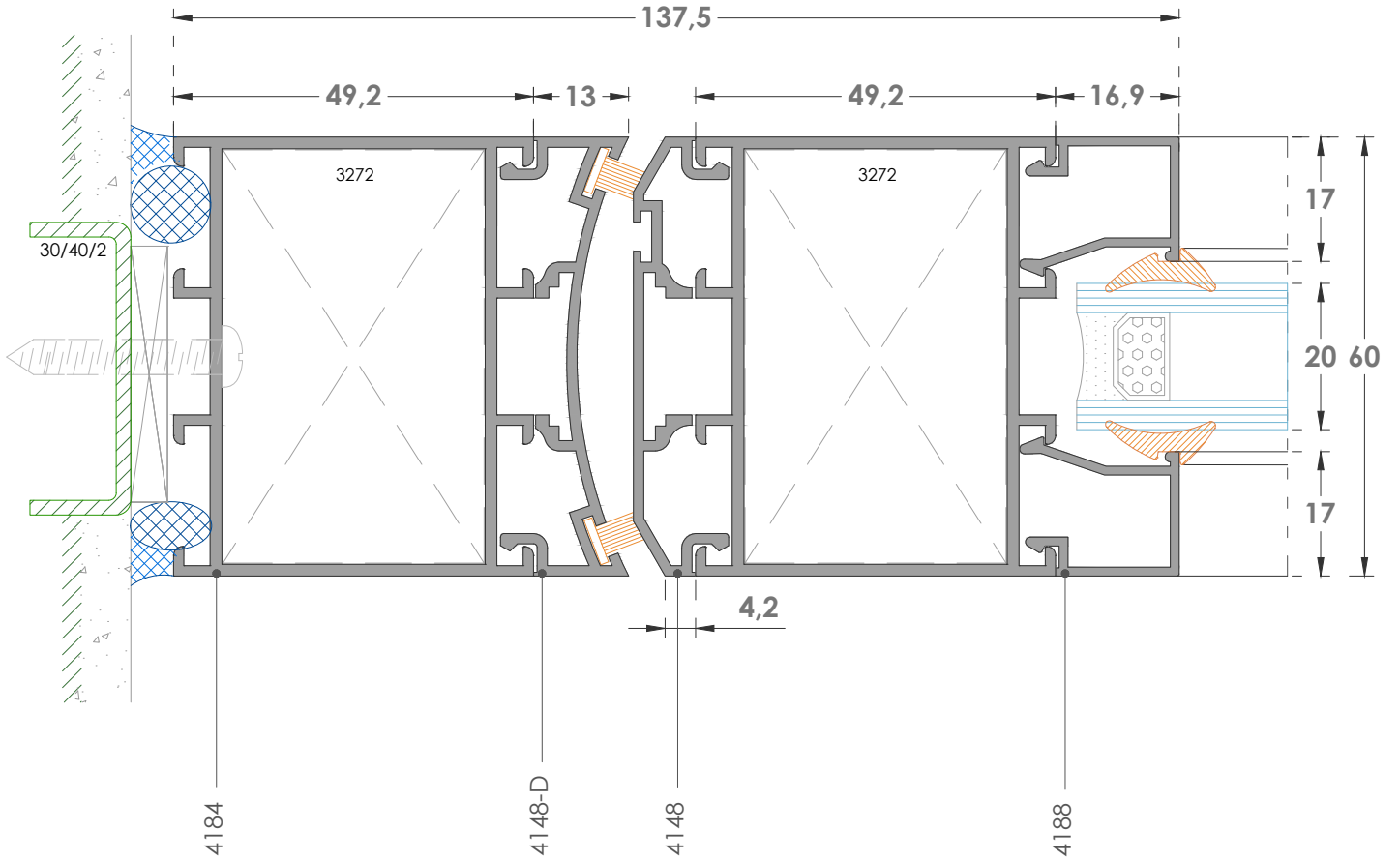

01

Detay-Detail

DIŞ - OUTSIDE

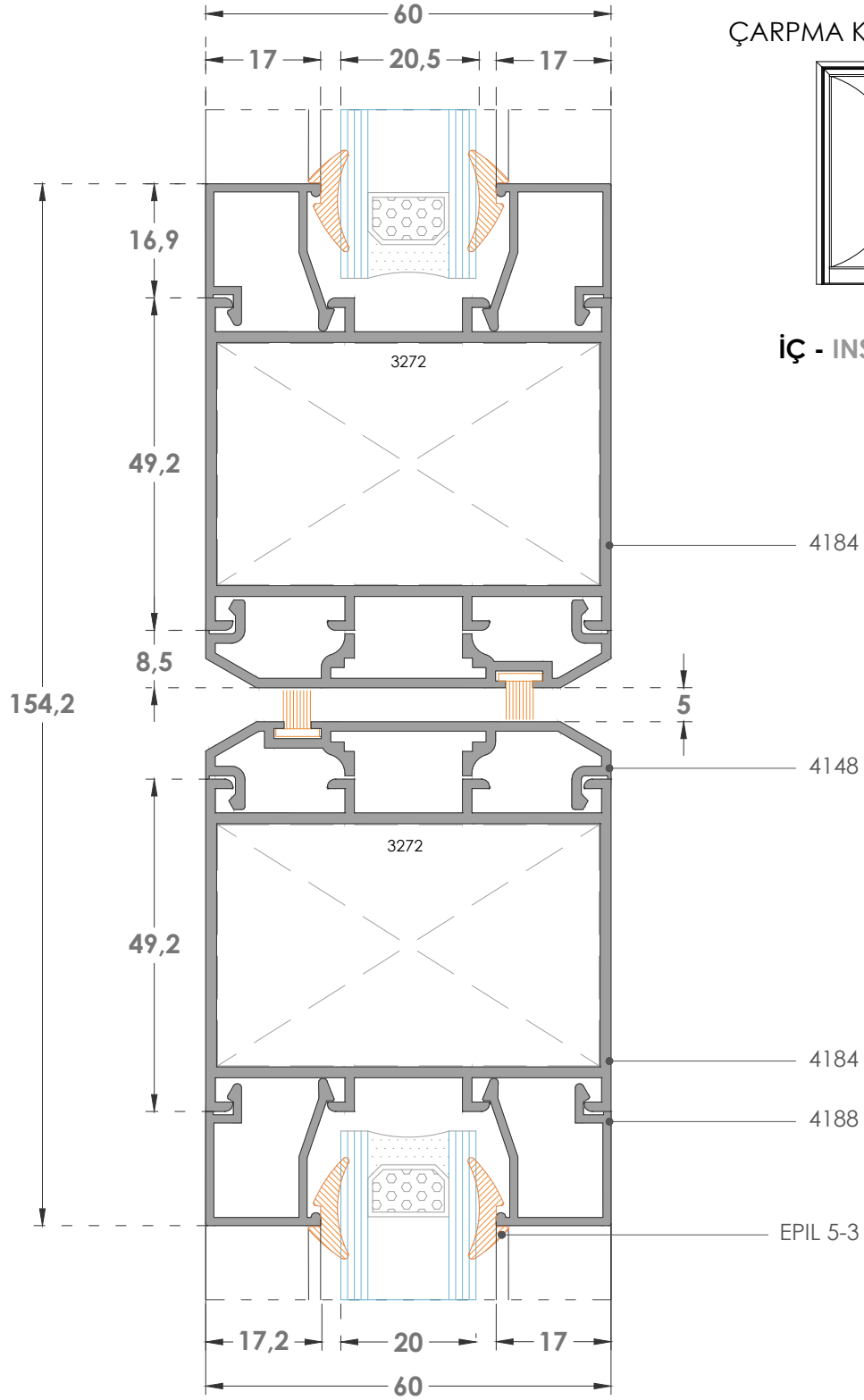

ÇARPMA KAPI / SWING DOOR

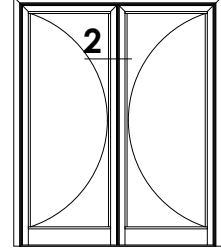

İÇ - INSIDE

DIŞ - OUTSIDE

02

Detay-Detail

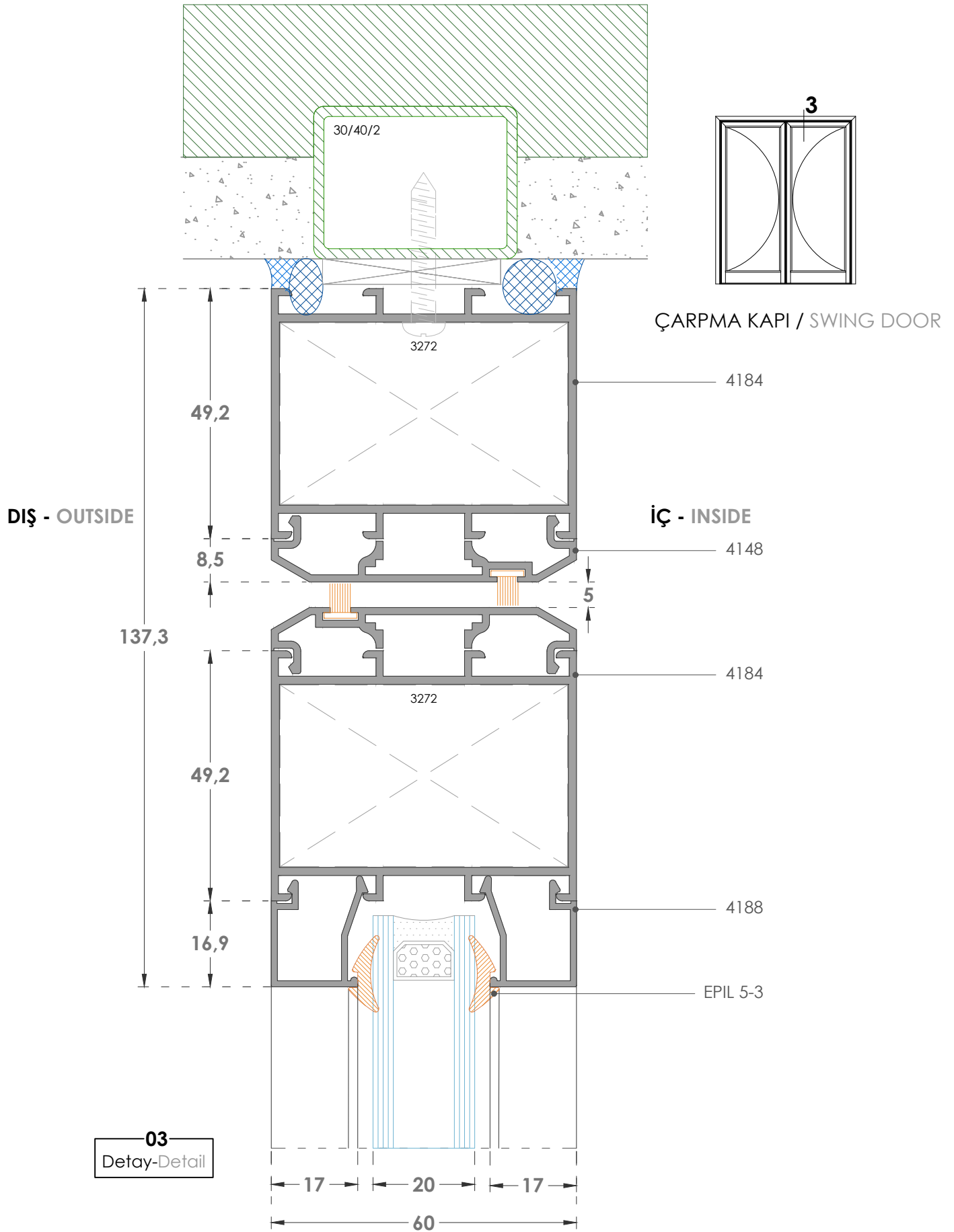

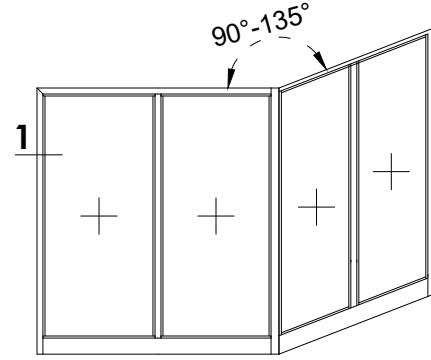

İÇ - INSIDE

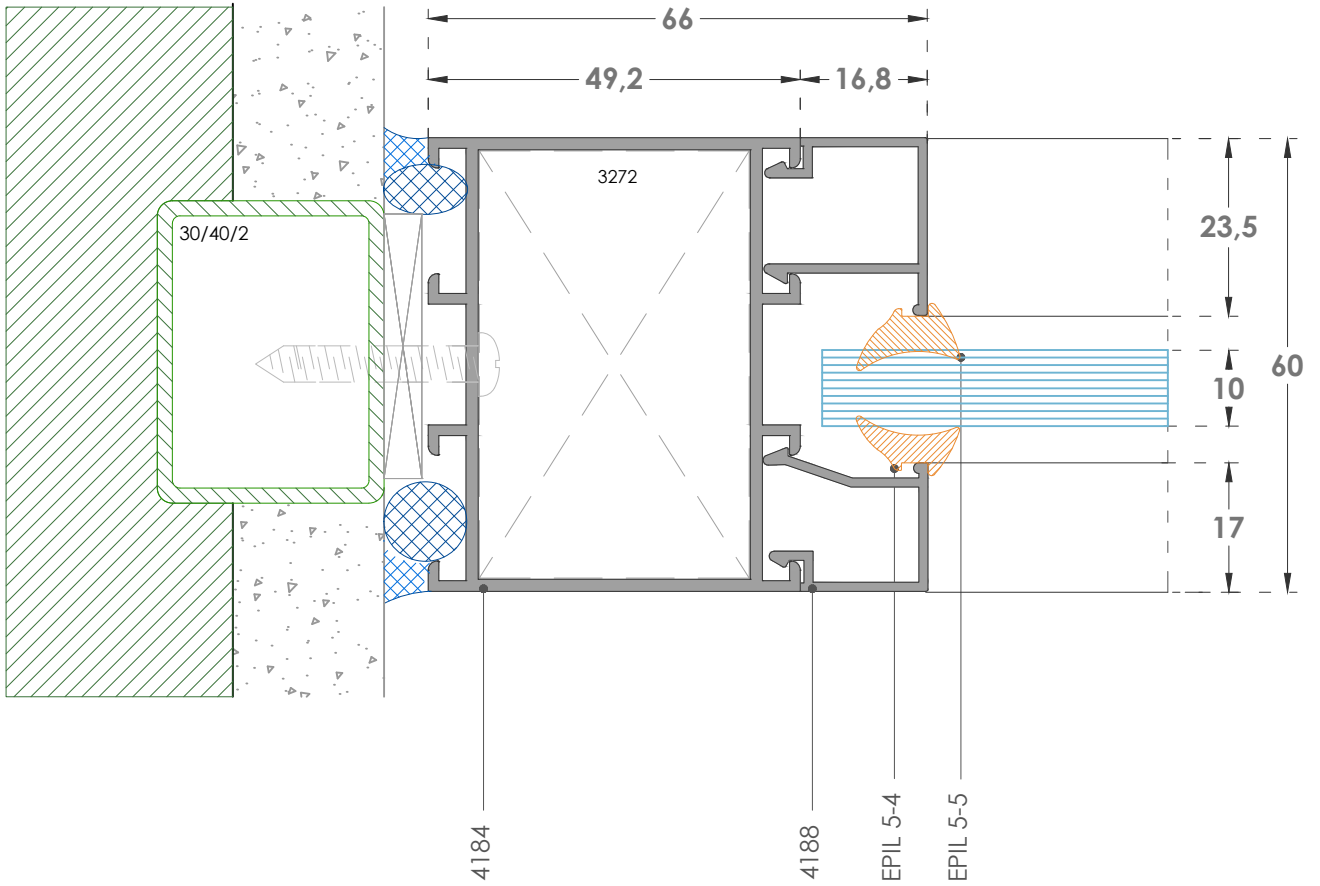

01

Detay-Detail

DIŞ - OUTSIDE

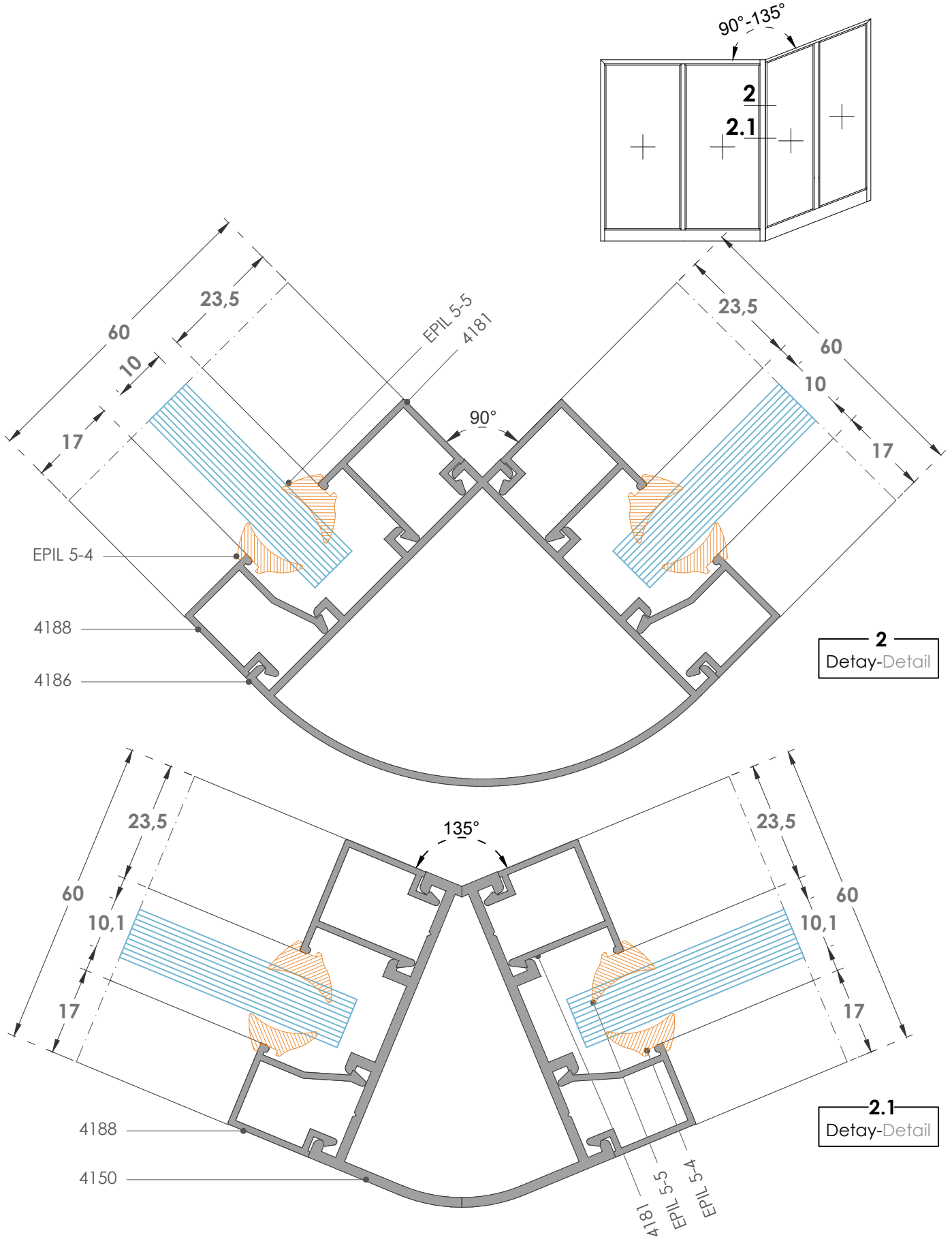

2
Detay-Detail

2.1
Detay-Detail

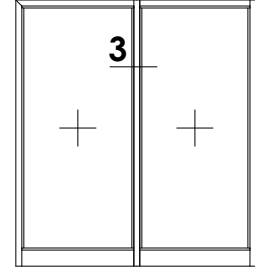

İÇ - INSIDE

